



MAGNUM HEATING

Comfort | Safety | Control



*Thermostaten los verkrijgbaar
Thermostats sold separately
Thermostate sind separat erhältlich

MAGNUM W-CONTROL SYSTEM

Quick guide



NL Onze producten zijn gefabriceerd met hoogwaardige en duurzame materialen. Om te garanderen dat uw product optimaal werkt zijn er enkele aandachtspunten, deze zijn beschreven in de installatievoorschriften. Alleen bij juiste montage volgens deze voorschriften kunnen wij u de volledige garantie geven. Lees voor montage deze voorschriften goed door en zorg voor het juiste gereedschap en materialen. U dient de elektrische installatie uit te laten voeren door een erkend installateur volgens de lokaal geldende normen.

Download de uitgebreide handleiding via magnumheating.nl

EN This MAGNUM Heating product is manufactured from high quality, durable materials. To guarantee your product functions optimally there are a few points of attention which are described in the Installation Instructions. We can only offer you the full guarantee if the system is correctly installed in accordance with these instructions. Carefully read the instructions prior to installation and ensure that you have the correct tools and materials. The electrical installation must be carried out by a qualified electrician in accordance with current local regulations.

Download the extended manual on magnumheating.com

D MAGNUM Produkte sind aus hochwertigen und langlebigen Materialien hergestellt. Um ein optimales Funktionieren Ihres Produktes gewährleisten zu können, haben wir noch einige Punkte, auf die wir Sie gerne aufmerksam machen möchten. Diese Punkte werden in der Installationsanleitung beschrieben. Nur bei korrekter Installation gemäß diesen Vorschriften können wir Ihnen eine vollständige Garantie gewährleisten. Lesen Sie diese Vorschriften gut durch bevor Sie mit der Montage beginnen und sorgen Sie für geeignetes Werkzeug und Materialien. Die elektrische Installation muss von einem anerkannten Installateur entsprechend den vor Ort geltenden Vorschriften ausgeführt werden.

Bitte laden Sie die erweiterten Bedienungsanleitung auf magnumheating.de

INDEX

- 4** **Aansluitschema**
Wiring diagram
Schaltplan

- 5** **Voorbeeld van een basis set-up**
Example of a basic set-up
Beispiel für eine Basis-Set-up

- 6** **Uitleg iconen quick guide**
Explanation icons used in quick guide
Erläuterung Kurzanleitung Symbole

- 7** **Instellen van W-Controller als “Master”**
Setting W-Controller as “Master”
W-Controller als “Master” einstellen

- 8** **Instellen van W-Controller als “Slave”**
Setting W-Controller as “Slave”
W-Controller als “Slave” einstellen

- 10** **Instellen van Zone 1 (Voorbeeld)**
Setting Zone 1 (Example)
Zone 1 einstellen (Beispiel)

- 11** **Instellen van Zone 2 (Voorbeeld)**
Setting Zone 2 (Example)
Zone 2 einstellen (Beispiel)

- 12** **De thermostaat bedienen**
Operating the thermostat
Bedienung der thermostat

- 14** **Download de App**
Download the App
Download der App

- 15** **Notities**
Notes
Aufzeichnungen

Aansluitschema

Wiring diagram

Schaltplan

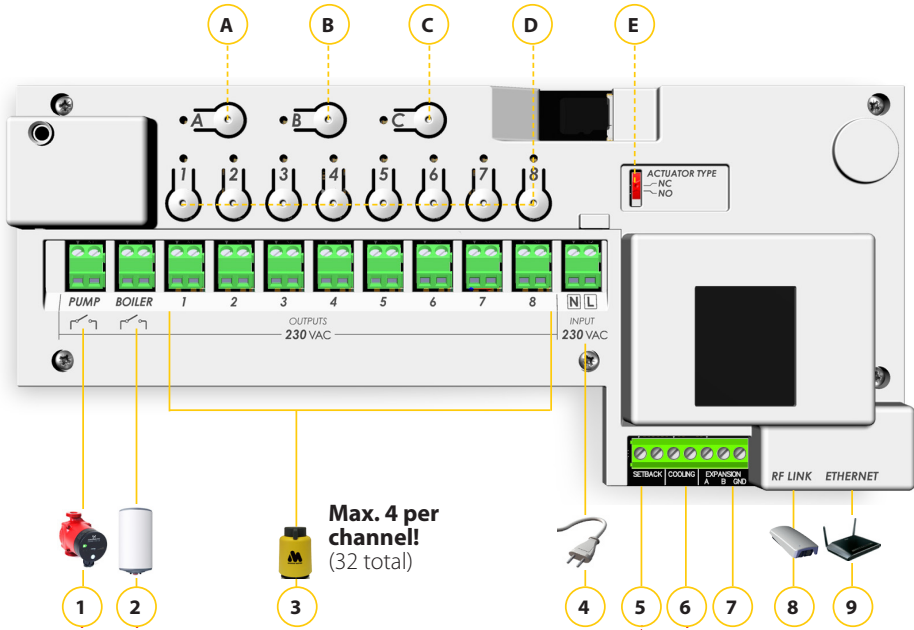

* Uitsluitend voor "Master" unit | * For "Master" Control unit only | Nur für "Master" Steuergerät

Aansluitpoorten:

1. Aansluiting voor pomp*
2. Aansluiting voor ketel*
3. Actuator poorten 1-8
4. 230V
5. Verlaging*
6. Koeling*
7. Expansie
8. Antenne (meegeleverd)
9. WLAN Basisstation (Internet modem)

Knoppen met LED indicatie:

- A. Selectieknop
- B. Selectieknop
- C. Selectieknop
- D. Kanalen (1-8)

Schakelaars:

- E. Actuator type NC/NO

Connection ports:

1. Pump connection*
2. Boiler connection*
3. Actuator ports 1-8
4. 230V Power supply port
5. Setback*
6. Cooling*
7. Expansion
8. Radio Antenna (Supplied)
9. WLAN Basestation (Internet modem)

Buttons with LED indicators:

- A. Selection button
- B. Selection button
- C. Selection button
- D. Channels (1-8)

Switches:

- E. Actuator type NC/NO

Anschluss-Ports:

1. Pumpenanschluss*
2. Kesselanschluss*
3. Aktoren-Anschlüsse 1-8
4. 230V Netzanschluss
5. Vermittlung*
6. Kühlung*
7. Erweiterung
8. Antenne (inbegriffen)
9. WLAN Basisstation (Internet modem)

Tasten mit LED-Anzeige:

- A. Auswahl Taste
- B. Auswahl Taste
- C. Auswahl Taste
- D. Kanälen (1-8)

Schalter:

- E. Actuator typ NC/NO

Voorbeeld van een basis set-up

Example of a basic set-up

Beispiel für eine Basis-Set-up

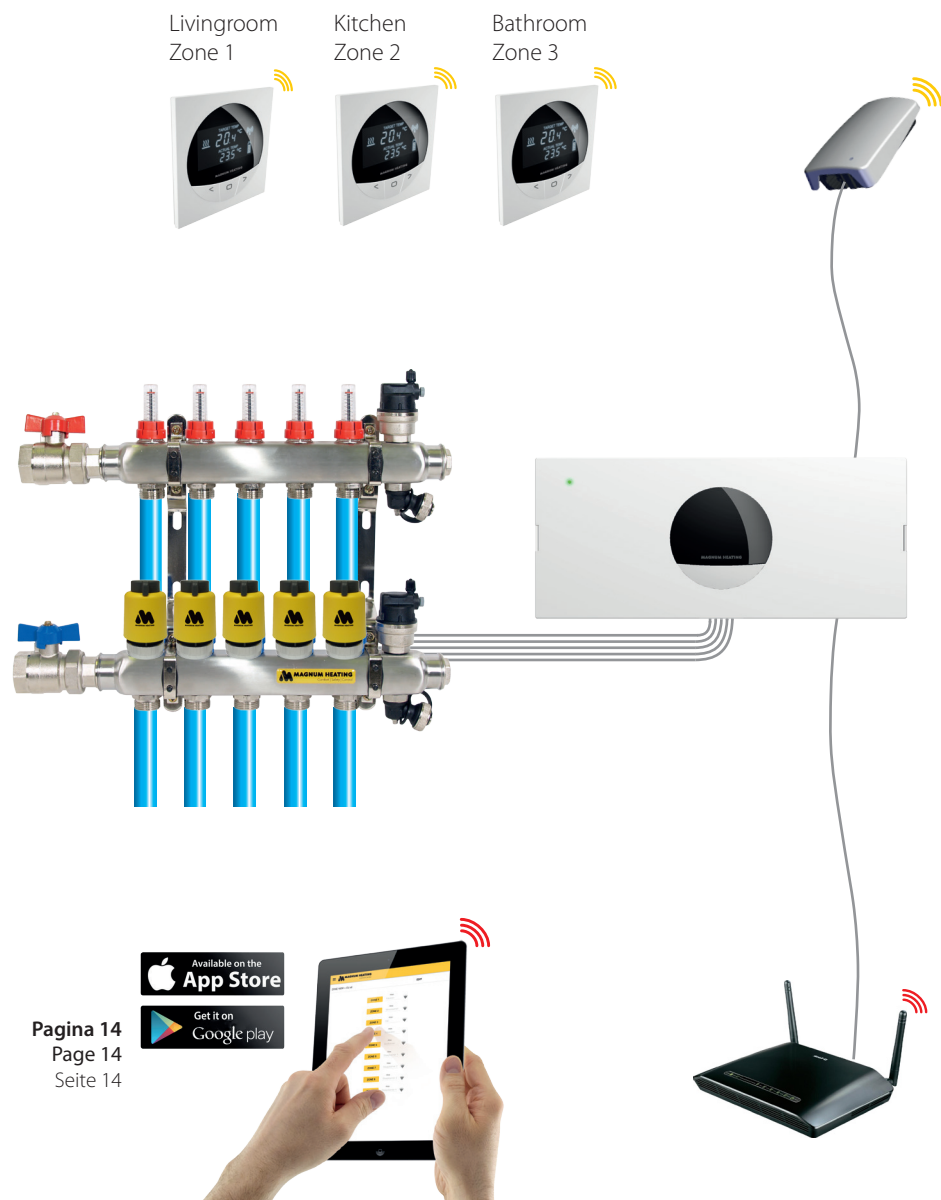

Available on the
App Store

Get it on
Google play

Pagina 14
Page 14
Seite 14



Uitleg iconen quick guide

Explanation icons used in quick guide

Erläuterung Kurzanleitung Symbole

 **LED aan**
LED on
LED leuchtet

 **LED knippert**
LED blinks
LED blinkend

 **LED knippert 1x/3x/5x**
LED blinks 1x/3x/5x
LED blinkend 1x/3x/5x

 **LED reeks aan**
LED series on
LED serie eingeschaltet

 **LED reeks knippert 1x**
LED series blinks 1x
LED serie blinkend 1x

 **LED reeks uit**
LED series off
LED serie aus

 **1x indrukken**
Press 1x
Einmal Eindrücke

 **3 sec. indrukken**
Press and hold for 3 sec.
Drücken und 3 Sek. halten

 +  **Beide toetsen 8 sec. indrukken**
Press both and hold for 8 sec.
Beide drücken und 8 Sek. halten

 **Observer**
Observe
Beobachten

 **Maak notitie op pagina 15**
Take note on page 15
Notieren Sie auf Seite 15

 **Wachten**
Wait
Warten

Instellen van W-Controller als "Master"

Setting W-Controller as "Master"

W-Controller als "Master" einstellen

1



● Device already set as "Master" or "Slave"?
● Not configured. Go to step 3

2 Factory reset:

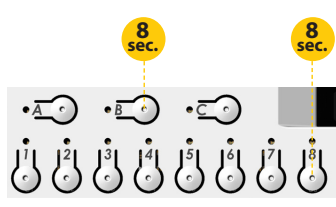

3

Set to "NC"

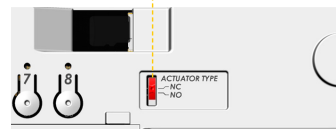

4

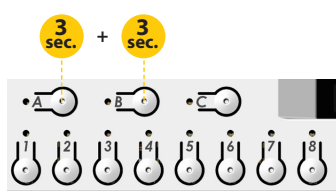

5

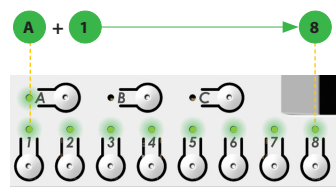

6 Set as Master:

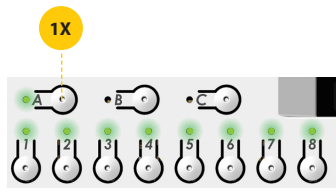

7

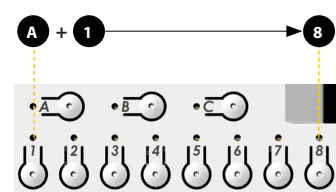

! Error?

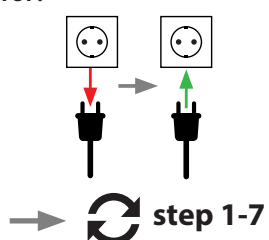

Instellen van W-Controller als "Slave"

Setting W-Controller as "Slave"

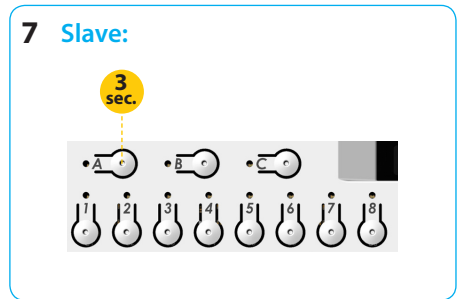
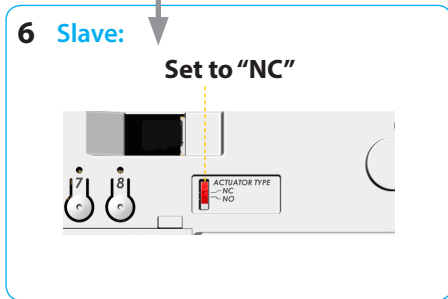
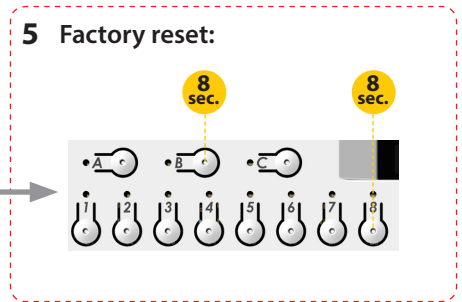
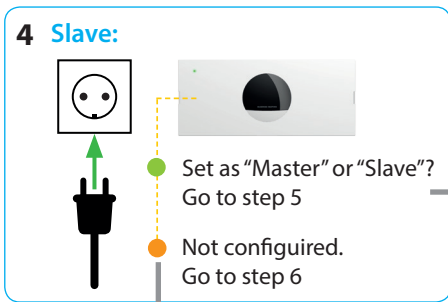
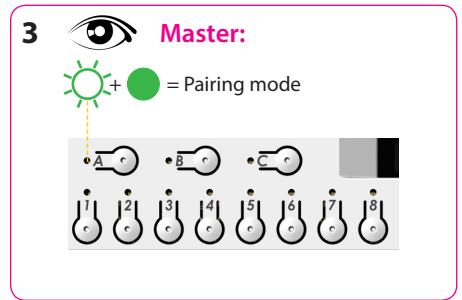
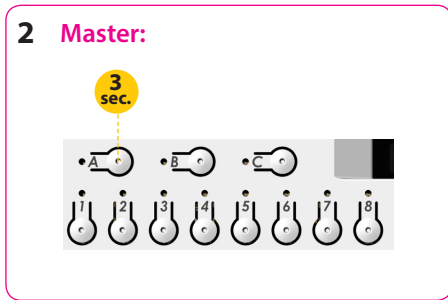

W-Controller als "Slave" instellen

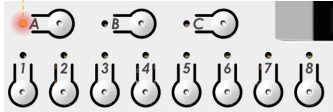

8  **Slave: Pairing mode**



9  **Slave: (🕒)**

 = Slave number → 

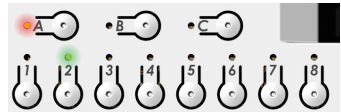

10  **Slave: (🕒)**

 = Confirm

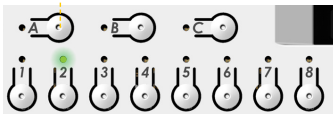

11 **Master:**



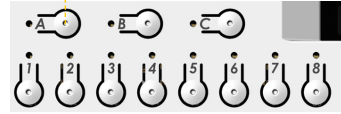

!  **Slave error?**



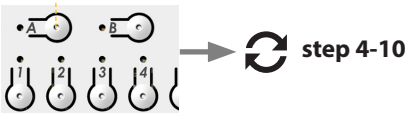

Slave 3-8?:  **step 1-10**

Instellen van Zone 1 (Voorbeeld)

Setting Zone 1 (Example)

Zone 1 einstellen (Beispiel)

1 Thermostat Zone 1

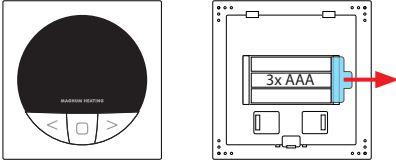

Remove battery foil

2 Target Controller

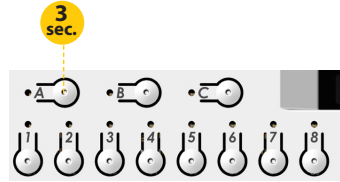

3



5x > ● = Pairing mode

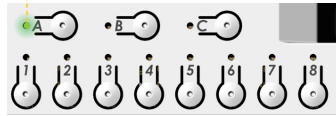

4

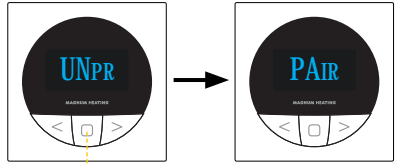

3 sec.



5



C1 = Controller 1 (Master) Z1 = Zone 1
 C2 = Controller 2 (Slave 1) Z2 = Zone 2
 C3 = Controller 3 (Slave 2) Z3 = Zone 3
 etc... etc...

6 Select channels Zone 1



1x 1x 1x

De-select? Press again.

7



2 sec. → 1x →



8



Zone 1 = Set:



Exit pairing mode



Instellen van Zone 2 (Voorbeeld)

Setting Zone 2 (Example)

Zone 2 instellen (Beispiel)

1 Thermostat Zone2

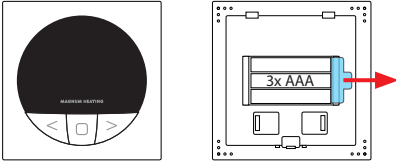

Remove battery foil

2 Target Controller

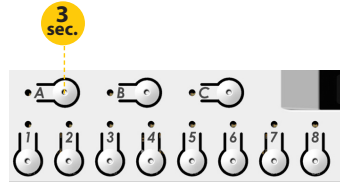

3



5x > ● = Pairing mode

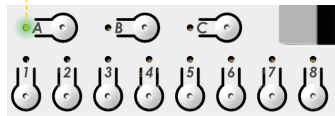

4 Thermostat Zone 2

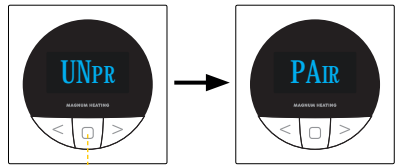

3 sec.



5 Thermostat Zone 2



6 Select channels for Zone2

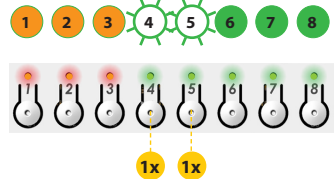

De-select? Press again.

7



2 sec. → 1x →



8 Zone 2 = Set:



Exit pairing mode ● A ● 1x

Zone 3?: ↻ step 1-8 etc.

De thermostaat bedienen

Operating the thermostat

Bedienung der thermostat







1. Manual temperature (Manual mode: 2.2)



2. Menu access



Menu:

-  2.1 Calendar mode
-  2.2 Manual mode
-  2.3 Holiday mode
-  2.4 Setback mode
-  2.5 RE RO ????
-  2.6 Button Lock
-  2.7 Backlight OFF/ON

2.1 Calendar mode



2.2 Manual mode



2.3 Holiday mode (All zones!)



2.4 Setback mode (All zones!)



2.5 Re-Connect (Thermostat to Controller)



2.6 Button Lock (from menu)



Unlock:

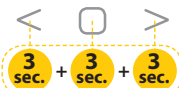
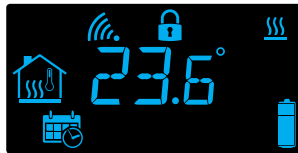

2.7 Backlight Off (from menu)



3 sec.

To confirm

Backlight back On?



3. Reset thermostat



3 sec.

+

3 sec.



3 sec.

To confirm

Download de App

Download the App

Download der App



Om toegang te krijgen tot het wekelijkse programma, zoek naar *“Magnum Control Center”* in de specifieke Appstore (Apple of Android) en download de app op uw apparaat.

Sluit de (MASTER) W-Controller naar het WLAN basisstation door middel van een Ethernet-kabel.

Start de MAGNUM-app op uw apparaat (zorg ervoor dat het apparaat een WiFi verbinding heeft via dezelfde WLAN basisstation) De App zal het netwerk scannen en de W-Controller webinterface openen.

To access and adjust the weekly heating mode, search for *“Magnum Control Center”* in the specific Appstore (Apple or Android) and download the App on your device.

Connect the (MASTER) W-Controller to the home WLAN base station physically through an ethernet cable.

Start up the MAGNUM App on your device (make sure the device is WiFi connected to the same WLAN basestation) The App will now scan the network and open the W-Controller Web user interface.

Um das Wochenprogramm zugreifen, wenn nach *“Magnum Control Center”* in der spezifischen Appstore (Apple oder Android) und die App auf Ihrem Gerät herunterladen.

Schließen Sie den (MASTER) W-Controller zu der drahtlosen Basisstation durch ein Ethernet-Kabel.

Starten Sie MAGNUM App auf Ihrem Gerät (stellen Sie sicher, dass das Gerät eine Wi-Fi-Verbindung hat mit der gleichen Wireless-Basisstation) Die App wird das Netzwerk scannen und Zugriff auf die W-Controller-Schnittstelle.



System name:	Master / Slave + nr.	Connected channels
Zone 1 Alias:		
Zone 2 Alias:		
Zone 3 Alias:		
Zone 4 Alias:		
Zone 5 Alias:		
Zone 6 Alias:		
Zone 7 Alias:		
Zone 8 Alias:		
Zone 9 Alias:		
Zone 10 Alias:		
Zone 11 Alias:		
Zone 12 Alias:		
Zone 13 Alias:		
Zone 14 Alias:		
Zone 15 Alias:		
Zone 16 Alias:		



C&F Technics
MAGNUM Heating B.V.
Slabbeoordweg 41
4691RZ Tholen

T +31(0)166-609 300
F +31(0)166-604 877
E info@magnumheating.nl
W magnumheating.nl